

24 Ports Full Gigabit Managed
Modular Ethernet Switch

User Manual

Preface



The user manual mainly introduces the product shape, product positioning, hardware installation, Web management and other related information.

Illustration

(1)Format of Graphics Interface

Format	Description
< >	"<>" means button name , such as "click <Confirm> button" .
[]	"[]" means window name, menu name and data table, such as "pop out [New user] window" .
/	"/" is used to seperate Multi-level menu. Such as [file/new/folder] multi-level menu [file] menu [new] sub-menu [folder] menu option.

(2)Various Signs

 Caution	Improper operation may damage the device or cause data loss.
 Instruction	Supplemental instruction for operation contents.

Content

1 Product Introduction	1
1.1 Overview	1
1.2 Product Feature	1
1.3 Board Diagram	2
1.4 Specification	3
2 Installation	4
2.1 Shipping List	4
2.2 Installation Precautions	4
2.2.1 Safety Precautions	4
2.2.2 Installation Requirements	5
2.2.3 The Requirements of Electromagnetic Environment	5
2.3 Installation Way	6
2.3.1 Rack Installation	6
2.3.2 Workbench Installation	7
2.3.3 Wall-hung Installation	7
2.3.4 8 ports copper module and 8 ports SFP module installation	8
2.4 Cable Connection	10
2.4.1 Device Connection	10
2.4.2 Configuration Cable Connection	10
2.4.3 Power Cable Connection	11
3 Function Configuration Guide	12
3.1 Computer Requirements	12
3.2 Set up Network Connection	12
3.2.1 Set Static IP for the Management Computer	12
3.2.2 Confirm the Network Connection by Ping Command	14
3.2.3 Cancel the Proxy Server	14
3.3 Web Page Configuration Guide	15
3.3.1 Start and Login	15
3.3.2 Change Language	16
3.3.3 Common Buttons Introduction	17
3.3.4 The Default Configuration	17
3.3.5 Web Users Timeout	19
3.3.6 Backup System Configuration Information	19
3.3.7 Restoring the Configuration Information	19
3.3.8 Quit	19
4 Web Management	20
4.1 System Status	20
4.2 Port Configuration	21
4.2.1 Port Settings	21
4.2.2 Port speed limited	23
4.3 VLAN Setting	24
4.3.1 VLAN Configuration	24
4.3.2 VLAN forwarding	26
4.4 Trunk Management	26
4.4.1 Trunk	26
4.4.2 RSTP	28
4.5 Port Security	31
4.5.1 Static Address Latch	31
4.5.2 802.1X certificates	32
4.6 Web Management	34
4.6.1 SNMP Setting	34
4.6.2 Email Alarm	35
4.6.3 Port Mirror	37
4.6.4 Multicast Snooping	38
4.7 Network Statistics	39
4.7.1 Network Statistics	39
4.7.2 MAC Address	40
4.8 System Management	40
4.8.1 IP Address	41
4.8.2 User Management	42
4.8.3 Log Information	43
4.8.4 File Management	44
4.9 PoE Management	45
4.10 QoS Management	47
4.10.1 QoS Setting	47
4.10.2 DSCP/ TOS QoS	48

1 Product Introduction

1.1 Overview

24 ports full Gigabit managed modular Ethernet switch, which provide 24* Gigabit downlink Ethernet ports or optical fiber ports, 2* Gigabit uplink optical fiber ports and 2* Gigabit uplink Ethernet ports.

24 ports full Gigabit managed modular Ethernet switch's downlink ports support Ethernet or optical fiber ports optionally (Including 8 Ethernet & 8 SFP pluggable modules). It is widely used in security surveillance, network engineering projects and so on.

1.2 Product Feature

- 24 ports full Gigabit managed modular Ethernet switch's 1-24 downlink ports support hot pluggable Ethernet or optical fiber modules and Mixed with Ethernet and optical modules, which is very convenient for network application that need both of them ;
- It provides web-based layer 2 network management by simple operation;
- Support high-speed data forwarding, very suitable for large flow of video data forwarding in security surveillance;
- Support recovery of IP address & user password by one key recovery button;
- Provides two power supply redundancy backup to improve the system reliability;
- Quick Installation, simple operation, convenient for wall/desk/rack installation.

1.3 Board Diagram

Board diagram of 24 ports full Gigabit managed modular Ethernet switch

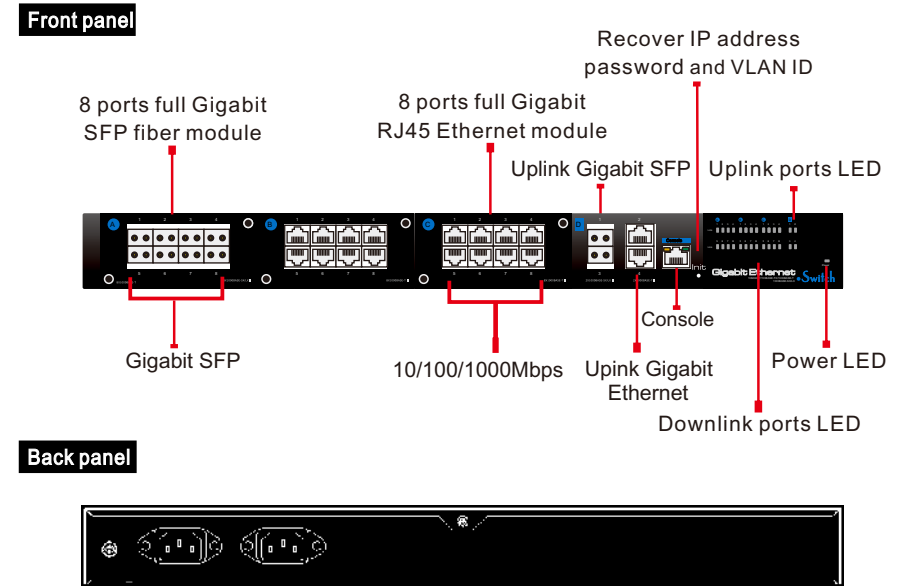

1.4 Specification

Item		24 Ports Full Gigabit Managed Modular Ethernet Switch
Power	Power Supply	Mains on load
	Voltage Range	AC 100~240V
	Consumption	2X60W
Network Connector	Ethernet Port	1~24 ports: 10/100/1000Mbps Ethernet ports or 100/1000Mbps SFP ports
		Uplink: 10/100/1000Mbps adaptive Ethernet port
	Transmission Distance	Uplink: 1000Mbps SFP Module port
Network Switch	Network Standard	Ethernet ports: 100m SFP ports: depend on SFP module
	Switch Capacity	IEEE802. 3, IEEE802. 3u, IEEE802. 3ab, IEEE802. 3z, IEEE802. 3X, IEEE 802. 1Q, IEEE 802. 1p, IEEE 802. 3ad
	MAC Address	56Gbps
Management	Management	16K
Protection	ESD	Management L2
	Lighting Protection	Grade 3 Pe: IEC61000-4-2
Environmental	Working Temperature	Grade 3 Per: IEC61000-4-5
	Storage Temperature	0℃~55℃
	Humidity(non-condensing)	-40℃~85℃
Mechanical	Dimension(LxWxH)	0~95%
	Material	442mm×315mm×44mm
	Color	Sheet Metal
	Weight	Black
		3. 78 kg

Item		8 Ports Full Gigabit RJ45 Ethernet Module	8 Ports Full Gigabit SFP Fiber Module
Network Ports	Network Ports	8 x 10/100/1000Mbps Ethernet ports	8 Gigabit SFP ports
	Distance	Ethernet ports: 100m	SFP: depend on SFP module
Mechanical	Dimension(LxWxH)	137mm×91mm×44.5mm	
	Material	Sheet Metal	Sheet Metal
	Weight	146g	142g

2 Installation



Caution

Anti-counterfeiting label is attached to switch's cover. Product damage caused by unauthorized disassembly is not covered under warranty.

2.1 Package List

Please check the following items before installation, if any missing, please contact your local dealer.

Item	Name	Quantity	Unit
1	Device	1	Set
2	AC Power Line	1	Piece
3	Accessory	1	Set
4	User manual	1	Book

2.2 Installation Precautions

To avoid device damage or personal injury by improper use, please observe the following precautions.

2.2.1 Safety Precautions



Instruction

This is level A product, which may cause radio disturbance in living environment. Users may need to take corresponding and effective measures to solve the problem.

- Pull out the power plug before cleaning the switch. Do not use wet cloth nor liquid to wipe or wash the switch;
- Do not leave the switch close to water or wet place so as to prevent water or dampness from entering into the switch;
- Make sure the switch work in a clean environment. Excessive dust may cause electrostatic adsorption, which will affect the equipment life and cause communication failure;
- The switch will work normally under the correct voltage. Please ensure the voltage indicated on the switch corresponds to the power voltage;
- To avoid the danger of electric shock, please do not open the switch case.
- Do not open the switch case even if the switch is powered off;
- The accessories (including but not limited to power cables, etc.), which can be used for the switch only, is prohibited for other applications.

2.2.2 Installation Requirements

The device should work in indoor environment to avoid thunder stroke. It is important to obey the following requirements no matter you install it in the cabinet or on the workbench directly:

- Enough space (larger than 10cm) for air outlet so as to facilitate the heating dissipation; Good ventilation system for cabinets and workbench is preferred;
- Ensure the Cabinet and workbench is sturdy enough to support the switch and it's accessories's weight;
- Cabinet and workbench with good grounding is preferred.

2.2.3 The Requirements of Electromagnetic Environment

When it is working, the switch may be affected by external interference outside the system through the ways of radiation and conduction. Please pay attention to the followings:

- AC power supply is TN system, so it is necessary to use single phase power socket (PE) which can protect ground wire so that the filter circuit can effectively filter out the power grid disturbances;
- The switch should work far away from high-power radio transmitters, radar transmitters, high-frequency devices;
- Use electromagnetic shielding if necessary, such as shielded cable;
- Interface cables should be arranged indoor rather than outdoor to prevent over-voltage or over-current damage to the signal port.

2.3 Installation Way

There are 3 installation ways: rack, workbench and wall-hung installation.

Caution

Please pull out the power plug before installing or moving the switch. Grounding and anti-lightening can greatly increase the protection level of the switch. please connect the grounding terminal to the earth area by using at least wire 20.

Instruction

The diagram is for reference only, the products are subject to actual product.

2.3.1 Rack Installation

Installation process:

- (1) Check rack with good grounding and stability;
- (2) Use screws to fit hangers at the device board side;

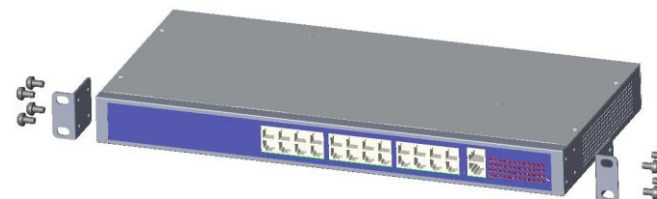

Figure 2-1 Install hangers diagram

- (3) Put the device on the rack's bracket and move the rack along the slot to proper position ;
- (4) Use screws to fit the installation hanger at rack's fixed slot, make sure the device is installed at rack's bracket steadily.

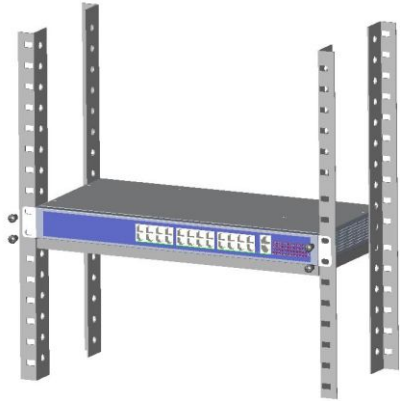

Figure 2-2 Install switch to the rack



Instruction

This product's fixing hangers are just to fix the switch rather than support it. Use brackets under the device (fixed to the rack) to support switch when install the switch to the rack.

2.3.2 Workbench Installation

You can put this product on clean, stable, grounded workbench. The installation procedure as below:

- (1) Carefully put the device upside down, clean the grooves on the chassis backplane with soft cloth to make sure there is no oil or dust in it;
- (2) Remove the stickers on the foot pad, paste the foot pad in backplane groove;
- (3) Carefully put the device upright on the workbench.

2.3.3 Wall-hung Installation

You also can put the product on clean, steady vertical wall. Installation procedure is below:

- (1) Use the screws to fix the hangers;



Figure 2-3 Hangers installation diagram

- (2) Drill holes on the strong position of wall and then drive the rubber plug into the hole;
- (3) Drive these screws into the hole for the rack and fix the product by aiming at the rubber plug .



Figure 2-4 Fix the switch on wall

2.3.4 8 ports copper module and 8 ports SFP module installation



Attention

The switch don't support installation with power on, please turn off the power.

Users open the host after packaging, loosen the product on a host of blank panel not to take off the screw, remove the blank baffle, 8 copper module or 8 SFP module into the switch slot, tighten the module on the loose screw. Please see the following module panel installation schematic.

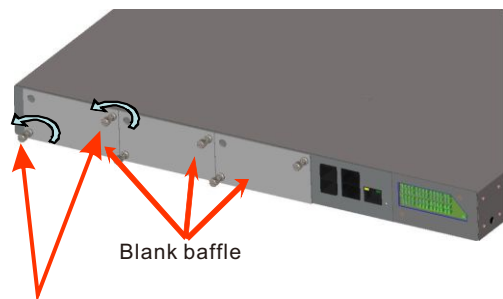

(1) unsrew towards the left;

Figure 2-5 How to remove the baffle-1

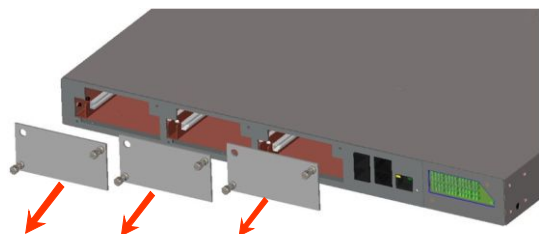

(2) Pull out the screw, remove the three baffles ;

Figure 2-6 How to remove the baffle-2

(3) Insert the SFP Module or RJ45 Module into the guide-track groove;

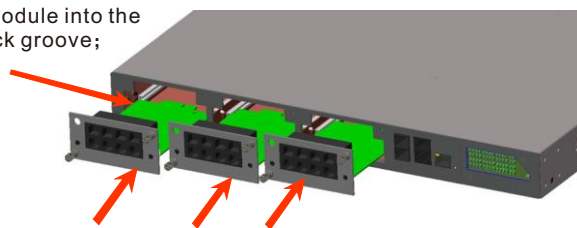

(4) Push the modules into the right place

Figure 2-7 How to install the module-1



(5) Tighten screws towards right, the modules is fixed well.

Figure 2-8 How to install the module-2

2.4 Cable Connection

2.4.1 Device Connection

Use cross network cable or cross-over cable to connect PC or other device with switch's Ethernet port;

2.4.2 Configuration Cable Connection

Use a network cable to connect Ethernet ports except the console port (Notice: The VLAN ID of this Ethernet port must be 1) with management PC, and use management PC to configure the PoE switch.



Figure 2-9 Connect configuration cable

2.4.3 Power cable Connection

- (1) Connect one side of switch's power cable with the switch's AC power port, and connect the another side with external AC power socket;
- (2) Turn on the power , check if switch's AC power LED is on, that means power connected correctly;
- (3) Use the power plug snap to jammed the AC Power cable.



Figure 2-10 Connect power cable

3 Function Configuration Guide

3.1 Computer Requirements

- Make sure the management PC has already been installed with Ethernet adapter;
- Use network cable connect Ethernet ports with network card of PC(Except the console port).

3.2 Set Up Network Connection

Instruction

- (1) You need to set the IP of the PC and the switch in the same network segment. The default IP address of the switch is 192.168.1.200, network gate is 255.255.255.0.
- (2) The port to connect management PC for Web setting must be management VLAN. By default, management VLAN is VLAN 1, and each port of the switch is VLAN1.
- (3) If you need to connect the remote network, please make sure the management PC and the router can do the job above.
- (4) This product can't assign the IP address for the management PC, you need to set the management static IP by yourself.

3.2.1 Set Static IP for the Management Computer

Operation steps (take Windows XP as sample):

- (1) Click <start> to enter the [start] menu, select "control panel". Double click "network connection" icon, double click the "local connection" icon, pop out "local connection status" window.

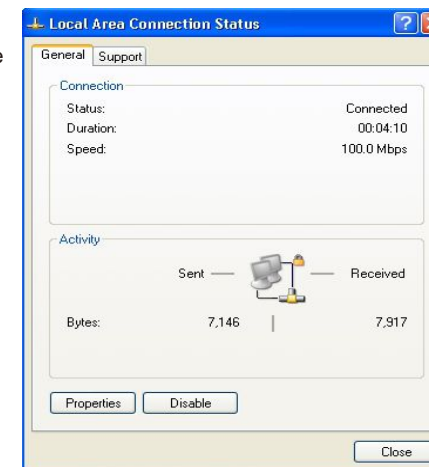

(2) Click <property> button, enter "local connection property" window.

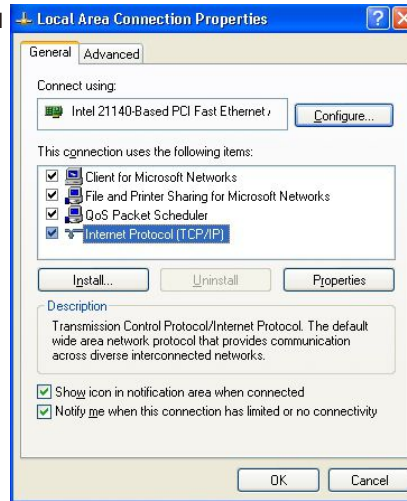

(3) Select "Internet protocol (TCP/IP), click <property> button, enter "Internet protocol (TCP/IP) property" window. Select " use the IP address below" button, input IP address (use arbitrary value between 192.168.1.1~ 192.168.1.254, besides 192.168.1.200) and the subnet mask(255.255.255.0). Click "OK" to finish the configuration.

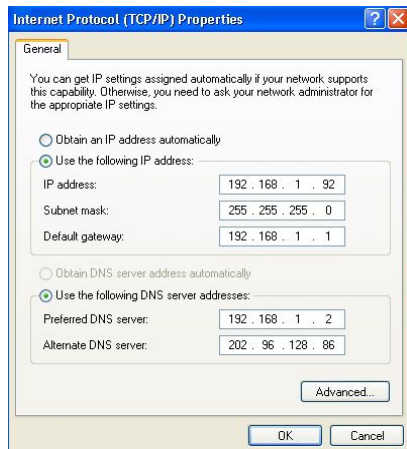

3.2.2 Confirm the Network Connection by Ping Command

Operation Steps below:

(1) Click <Start> button to enter [Start] menu, select [Run], pop out the dialog.

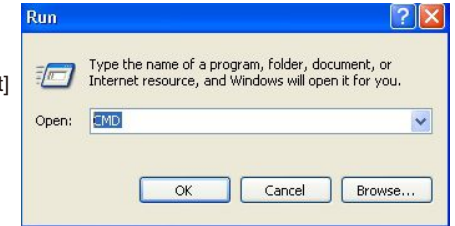

(2) Input "ping 192.168.1.200", click <confirm> button. If there is equipment response show in the pop out dialog, that means network connection succeed, otherwise please check if the network connection is correct.

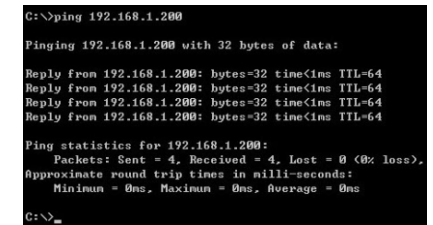

3.2.3 Cancel the Proxy Server

If this management PC use proxy server to visit the internet, then you must prohibit the proxy service, following is the operation:

(1) In browser, select [tool/Internet option] enter [Internet option] window.

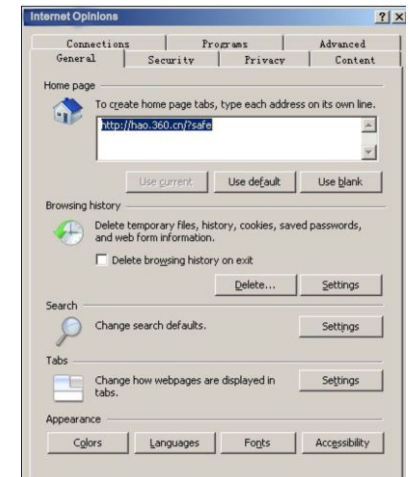

Instruction

DNS server address can be empty or be filled in with the real server address.

(2) Select “connection” tabs in [Internet option] window, and click [LAN Setting] button.

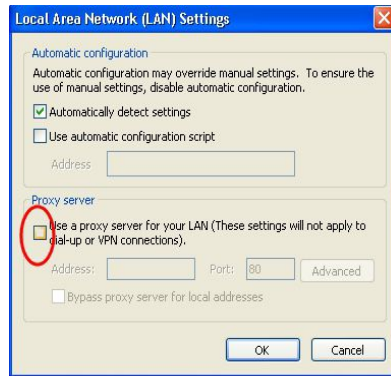

(3) Make sure the “Use proxy server for LAN” option is not selected. If selected, please cancel it and click <yes> button.

The menu bar has the following options: [System Status], [Port Configuration], [VLAN Settings], [QoS management], [link management], [Port Security], [network management], [Network Statistics], [System management], [Exit] and drop-down menu bar of the “language switching function”. Click a option to make corresponding setting. The following will explain the function of each option.

3.3 Web Page Configuration Guide

The browser version recommend : IE7 and later, Firefox browser, Chrome, 360 browser (IE7 and later).

3.3.1 Start and Login

This product web default IP address: 192.168.1.200, subnet mask: 255.255.255.0, administrator account: admin, password: admin. After installing the equipment correctly and setting up the computer, open the browser, input the switch default address in the browser address bar: <http://192.168.1.200>, then press the Enter key, the user login page will show in front of you as follows:

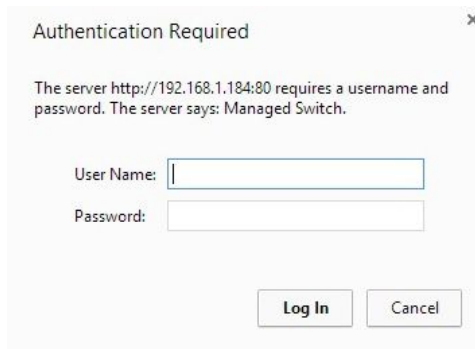

Caution

Please follow the steps to check if the switch is installed correctly:

- (1) Whether the physical connection of the equipment is correct? Use network cable to connect the product's Ethernet port(except the console port) with managed computer network card, and ensure the link LED of the port is on.
- (2) Whether the computer TCP/IP agreement setting is correct? Your computer's IP address must be 192.168.1.x (x range is 1~254 and x can not be 200, otherwise it will conflict with the product IP address 192.168.1.200), subnet mask: 255.255.255.0.
- (3) Whether the computer's port VLAN ID is 1? By default, the management VLAN is VLAN 1, same as each port of switch.

After inputting the correct password, click <Login in>, the browser will display the product Web management page as the picture below:

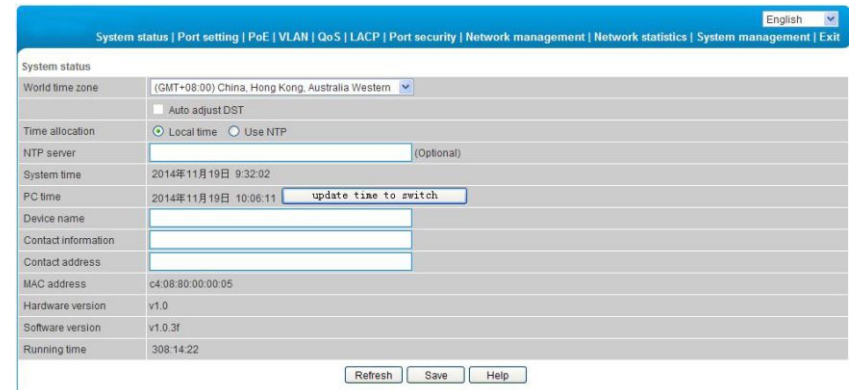

Web management page diagram

3.3.2 Change Language

As shown below, in the upper right corner of the Web page, click on the drop-down menu bar, select [Chinese] or [English], to complete Web language switching.



Web English language switching page diagram

3.3.3 Common Buttons Introduction

Table 3-1 Web commonly used function buttons introduction

Button	Function
Help	Open the online help page of Settings page to display the help information for current page.
Confirm	Submit the input information and confirm the information the current system provided.
Cancel	Cancel the current configuration input
Return	Return to the previous page
New page	Create a new project of the current page
Select all	Select all the ports of the current page
Refresh	Refresh the current configuration page
Delete all	To delete all configuration items the section selected

3.3.4 The Default Configuration

The following table lists some important default configuration of the switch, all features will be described in details in following chapters. The default configuration is for most cases. Please reconfigure if the default configuration does not match the actual requirements.

Table 3-2 Default Configuration

Options		Default Configuration
System	Username / password	admin/admin
	IP Address	IP Address: 192.168.1.200 Subnet Mask: 255.255.255.0
	MAC address table aging time	300 Seconds
Port	Ports Status	Enable
	Ports Speed Rate	Auto-negotiation
	Port duplex mode	Auto-negotiation
	Flow Control	Open
	Trunking	Port does not converge
	Port Speed Limitation	No limitation for Speed
	Port Link Type	Access
VLAN	Management VLAN	VLAN 1
	VLAN Function Mode	Port-based VLAN
MAC Binding		No Binding
RSTP	RSTP Function	Close
Network Management	SNMP	Close

3.3.5 Web User Timeout

When you have left the Web setting page for a while, the system will log out and return to the Web dialog box due to system time-out. Please log in again if you want to proceed the operation.

Instruction

Web page login timeout setting defaults to 5 minutes.

3.3.6 Backup System Configuration Information

Click <Backup> button to select the configuration file backup path, click <OK> button to save the current configuration for the computer. The configuration can be restored through the document [* .cfg] .

3.3.7 Restoring the Configuration Information

Click <Browse> button, select previous backup file[* .cfg], click <Recover> button. The configuration information stored in the backup file will be restored to the device, the configuration takes effect after the device restarts automatically.

3.3.8 Quit

Click the [Exit] menu item in navigation bar, return to the system status page, the login box will be popped out automatically till the next click on the page.

4 Web Management

4.1 System Status

The meaning of specification in the page shown as below.

Table 4-1 Specifications description

Specification	Description
Word Time Zone	Display different time zones around the world. For example, select Automatically Adjust Daylight Saving Time in daylight saving time zone.
Time Configuration	You can select local time or use NTP
NTP Sserver	NTP is used when all the equipment clocks in the network have to be kept the same so as to ensure the accuracy of the clocks. Enter the correct NTP server's IP address to start the setup.
System Time	The current time of the device, if you did not get the NTP updated time, then it will start to count from 0:00,1970.
PC Time	Computer current time
Device Name	Network identification device used to facilitate the integrated management tools such as SNMP to judge different equipment.
Contacts	Equipment maintenance personnel's Contact Information
Contact Address	Equipment maintenance personnel's Contact Information
MAC Address	Hardware address of the device is unique since it is determined by the length of 48 bits (6 bytes), Hexadecimal digits.
Hardware, Software Version	Pay attention to software release limit for the hardware version. There are more functions in the updated software version, some of which have new requirements about hardware version.
Running Time	The time period since equipment has been running. when the device is restarted, the time needed to be recalculated.

4.2 Port Configuration

4.2.1 Port setting

16 port switch panel silkscreen port and Web port corresponding table

24 Ports Full Gigabit Managed PoE Ethernet Switch															
Web Port	1	2	3	4	5	6	7	8	9	10	11	12		25	27
Silkscreen Port (up)	A1	A2	A3	A4	B1	B2	B3	B4	C1	C2	C3	C4		D1	D2
Web Port	13	14	15	16	17	18	19	20	21	22	23	24		26	28
Silkscreen Port (down)	A5	A6	A7	A8	B5	B6	B7	B8	C5	C6	C7	C8		D3	D4

24 port switch panel silkscreen port and Web port corresponding table

24 Ports Full Gigabit Managed Modular Ethernet Switch															
Web Port	1	2	3	4	5	6	7	8	9	10	11	12		25	27
Silkscreen Port (up)	1	2	3	4	5	6	7	8	9	10	11	12		1	2
Web Port	13	14	15	16	17	18	19	20	21	22	23	24		26	28
Silkscreen Port (down)	13	14	15	16	17	18	19	20	21	22	23	24		3	4

On the [Port security / Port Settings] page, you can observe all the current switch port status information and can set [Port Enabled], [port rate], [Flow Control], [Port range], shown as figure 4-1.

The screenshot shows the 'Port setting' configuration page. It includes dropdown menus for 'Port enable' (set to 'Enable'), 'Port rate' (set to 'Auto negotiation'), 'Duplex mode' (set to 'Auto negotiation'), and 'Flow control' (set to 'Enable'). There are 'OK' and 'Refresh' buttons. Below the settings is a table with the following data:

	Port	Port mark(Double-click to modify)	Current status (speed/duplex)	Port status			
				Port property	Port rate(speed/duplex)	Flow control	Port enable
<input type="checkbox"/>	1	port1	no link	Copper	100M/Auto	enable	enable
<input type="checkbox"/>	2	port2	no link	Copper	Auto/Auto	enable	disable
<input type="checkbox"/>	3	port3	no link	Copper	Auto/Auto	enable	enable
<input type="checkbox"/>	4	port4	no link	Copper	Auto/Auto	enable	enable
<input type="checkbox"/>	5	port5	no link	Copper	Auto/Auto	enable	enable
<input type="checkbox"/>	6	port6	no link	Copper	Auto/Auto	enable	enable

Figure 4-1 Port configuration

The specification meaning in this page shown as below

Table 4-2 Specification

Specification	Description
Port Enable / Disable	Display the data forwarding of the port. If a port is off, you can not forward the data. Enabled by default.
Port Speed Rate	Display the port configuration's speed rate, including 10M, 100M, 1000M, auto-negotiation. It defaults to Auto-negotiation, which means the port can automatically and directly connected the device on the other side to negotiate the port speed. It defaults to Auto-negotiation mode.
Duplex Mode	Display the port configuration's duplex status, including full-duplex mode, half-duplex mode, and auto-negotiation mode. It defaults to auto-negotiation mode.
Flow Control	Choose whether to enable the function of flow control. When two switches have enabled the function of flow control, if one of the two switches has been congested, it will send a message to the other switch to notify it to temporarily stop sending messages or slow down the sending speed. After receiving the message, the other switch will stop sending or slow down the sending speed of messages so as to avoid packet loss and ensure normal operation of network services. By default, the flow control function of the port is enabled.

Configuration direction:

To set the port 1-10 to 100Mbps half duplex mode, and disable the flow control function, please follow these steps:

- To set the port 1-10 to 100Mbps half duplex mode, and disable the flow control function, please follow these steps:
- Enter 1-10 (or click on the box in front of the port) in the range of ports;
- Click the port speed drop-down menu to select 100Mbps;
- Click dual-duplex mode on the drop-down menu to select half-duplex;
- Click flow control the drop-down menu to select the Disable;
- Click Edit;
- Operation ends.

Instruction

1-24 port for pluggable module, and port attribute is determined by the selected modules. When selecting 100M optical module, you need to manually set the port rate to 100M mode.

25-26 ports for uplink optical port, at fixed rate of 1000Mbps.

27-28 port is fixed uplink Ethernet ports at a rate of 10/100 / 1000Mbps adaptive.

4.2.2 Port speed limit

The Equipment provides port-based entry speed limit. Users can restrict every port traffic flows or cancel port flow restrictions. Users can choose a fixed rate, the range is: downlink ports 1~1000Mbps, uplink port 1~1000Mbps, Accuracy is 1Mbps. Port restrictions including Unicast packets, Multicast packet and broadcast packet.

In [ports setting/ port speed limit] page, could modify [port speed limit] function setting, as the figure 4-2 show.

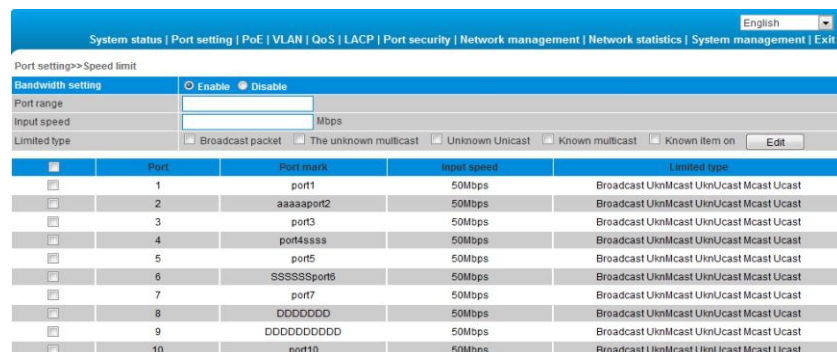

Figure 4-2 Port speed limit

The meaning of the parameters on this page are as shown below.

Table 4-3 Parameter description as the following table:

Specification	Description
Bandwidth Settings on / off	Turn on or off the port speed limited, the default is off
Port range	The port that need speed limited
Input rate	The max input rate of each port
Limited type	Port limited type including all Unicast packets, multicast

Configuration direction:

Such as control the rate of 1-5 ports to 50Mbps, limited type is Broadcast packet.

- Turn on ports rate;
- Input 1-5 in port range, input rate is 50, limited type is Broadcast packet.
- Click save;
- Operation finished.

4.3 VLAN Setting

Switch supports two VLAN modes:

- (1) Port-based VLAN mode: define VLAN members according to device port. After you specify the port to a VLAN, specified VLAN Packets can be forwarded by the port.
- (2) 802.1Q VLAN mode: Defined by IEEE802.1Q protocol. Process the packets by identifying the packets tags.

4.3.1 VLAN Configuration

On [VLAN / Port VLAN] page, you can observe the VLAN settings of all the current port switch and can set several functions such as [Port range], [Link type], [Default VLAN ID], [VLAN forwarding list], [vlan-untagged mark list], as shown in figure 4-3.

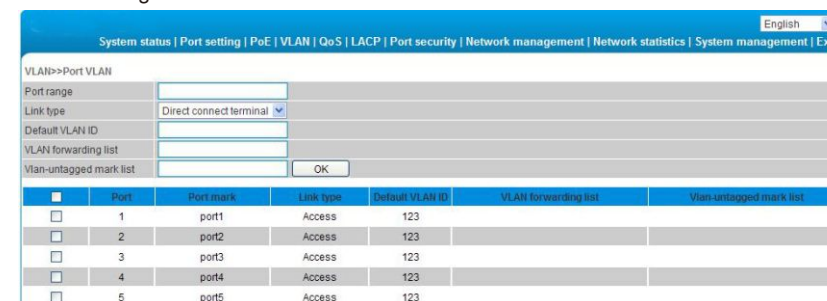

Figure 4-3 VLAN setting

The meaning of the parameters on this page are shown as below.

Table 4-4 Parameter description as the following table:

Parameter	Description
Link Type	Access : port, which is normally used for connecting devices, only belongs to one VLAN. By default, all ports are Access ports. Trunk : port belongs to multiple VLAN and can receive and send multiple VLAN packets. It is normally used to connect network devices.
Default VLAN ID	Enter the ID number which is needed to be divided. (generally 1-4094)
VLAN Forwarding list	VLAN packets can be transferred, other will be discarded.
VLAN untagged mark list	Port forwarded packets can be set in VLAN. Untagged without a tag, but other can not.

Configuration Guide :

Such as if port 1-10 has connected to a switch respectively, it is necessary to divided port 1-10 into VLAN 20.

- Enter 1-10 within the port range(or click on the box in front of the ports);
- Choose Trunk on the menu(Switches connection is generally used with Trunk mode);
- Enter 20 to default VLAN ID;
- Enter 1-10 to VLAN forwarding;
- Enter on VLAN flag list based on actual relationship (the receiving and sending of packets for port is shown in Table 4-5);
- Press Set to save the setting;
- Operation finished.



Instruction

VLAN ID range is 1-4094, VLAN flag list must be in the range of VLAN forwarding list.

Table 4-5 Port processing of transferring and receiving message.

Port Type	Received message process		Transferred message process
	Received message without Tag	Received message with Tag	
Access	The default VLAN ID port for the packet with the corresponding VLAN Tag.	When the VLAN ID and default VLAN ID is the same, receive the packet. Otherwise discard the packet .	Delete message Tag before transferring it.
Trunk	Compare port default VLAN ID to check whether it is allowed by the VLAN ID, if yes, the default message with port VLAN ID corresponding VLAN Tag; if No, discard the packet.	When VLAN ID allowed to pass through in the VLAN ID, then receive the packet. Otherwise discard the packet .	When the VLAN ID and default VLAN ID is the same, remove the tag and send the message. When the VLAN ID and default VLAN ID is different, and is allowed to pass through the port, maintain the original tag and send the message.



Caution

The default port VLAN and allowed VLAN must be existed VLAN.

4.3.2 VLAN Forwarding

On [VLAN / VLAN forwarding] page, you can observe the current port VLAN forwarding information, shown in figure 4-4.

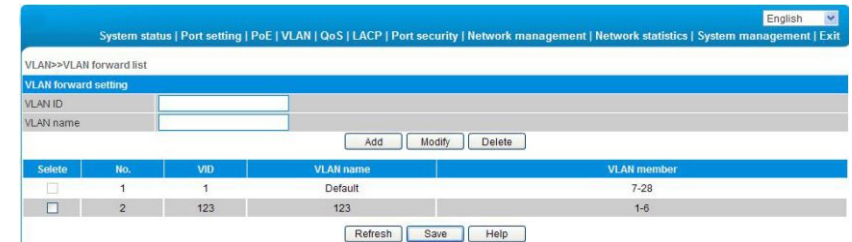

Figure 4-4 VLAN forwarding

The page parameter description as the table shown.

Table 4-6 Parameter description

Parameter	Description
VLAN ID	VLAN ID needed to be changed
VLAN Name	Change the VLAN name that need configuration

Configuration Instruction:

Such as revise VLAN20 name from sales department to financial department.

- Enter 10 to VLAN ID (or click on the box in front of the VID10);
- Enter financial department to VLAN Name;
- Press Revise to save the setting;
- End.

4.4 Trunk Management

4.4.1 Trunk

TRUNK means port convergence, configure the software settings and connect two or more physical ports to become a logical path to increase the bandwidth between switches and network nodes. The bandwidth merge of several ports provides an exclusive high bandwidth several times than an independent port.

On [LACP / TRUNK] page, you can observe the current port link convergence information, shown in figure 4-5.

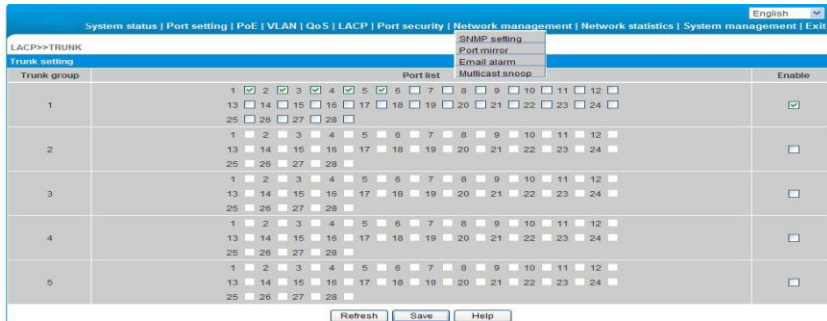

Figure 4-5 Trunk link



Instruction

Each convergence group supports up to eight ports. Port with the following cases can not be added to an convergence group:

- (1) Port with 802.1X function;
- (2) The mirror port;
- (3) Port with MAC address binding.

Configuration Guide:

Such as connect the switch A's 1-2 ports with switch B's 1-2 ports

- Enable a convergence group in switch A;
- Select 1 and 2 ports;
- Click Save;
- Switch B and Switch A are in consistent procedure;
- End.



Caution

In the same convergence group, the port speed, duplex mode, and basic configuration must be consistent.

STP consistent configuration, including STP ports on / off, STP priority, STP cost, whether to open loop guard and root guard, or edge ports.

QoS configuration is consistent.

VLAN consistent configuration, including permitted VLAN, the default port of VLAN ID. Link type on the ports is consistent.

4.4.2 RSTP

4.4.2.1 RSTP Uses

STP (Spanning Tree Protocol) is established in accordance with IEEE 802.1D standard. It is developed for the elimination of the data link layer loops in the LAN protocol. Devices running this protocol exchange packets with each other to find loops in the network, and choose to block some certain ports. This will eventually make the loop network structure into a loop-free tree pruning network structure. Thus it prevents packet proliferation and infinite cycling in loop network, avoiding declined processing capacity and receiving same messages repeatedly.

STP contains two meanings, narrow meaning of STP is defined in IEEE 802.1D, board meaning of STP includes IEEE 802.1D defined STP and various enhanced spanning tree protocol produced on the basis of STP (such as RSTP protocol).

4.4.2.2 STP Basic Concept

- (1) The root bridge

Network structure tree must have a root, then STP introduces the concept of root bridge in. Only one root bridge and the root bridge will change when the network topology changes, so the root bridge is not fixed.

- (2) The path cost

Path cost is a reference value for STP to select a link. By calculating the path cost of STP, STP chooses stronger links to block redundant links and cut the network into a loop-free tree topology.

- (3) The port role

Root port: responsible for forwarding data to the root port.

Designated port: responsible for forwarding data to the downstream of network segment or switch port.

Block Port: port suppressed by other's specific ports.

- (4) Port status

Forwarding: Forwarding user traffic, only the root port or designated port have this condition.

Learning: The switch builds the MAC address table according to user traffic received (but not forwarding traffic).

Listening: the completion of the root bridge, select the root port and designated ports.

Blocking: Only BPDU is received and processed, no user traffic forwarded.

Disabled: consider blocking or link disconnection.

- (5) The designated bridges and designated ports

The meaning of designated bridges and designated ports is shown in Table 4-7 below.

Table 4-7 Designated port status

Classification	Designated Bridge	Designated Port
For equipment	Equipment connecting directly with switch and responsible to transfer BPDU message to switch	Port used by designated bridge to transfer BPDU message to switch
For LAN	Responsible to transfer BPDU message to local network segment equipment	Port used by designated bridge to transfer BPDU message to local network segment

4.4.2.3 RSTP Introduction

RSTP (Rapid Spanning Tree Protocol) is an optimized version of STP. It is “fast” because the delay is shortened under certain conditions when a port is selected as the root port and designated port to enter to the forwarding state, thus the time to reaching topology stability is greatly reduced.



Instruction

In RSTP, to ensure fast move of root port: the old root port of the device has to stop forwarding data and the upstream designated port has to start forwarding data.

In RSTP, to ensure fast move of designated port: the designated port should be an edge port or a port connected to point to point link. If the designated port is an edge port, the designated port can enter the forwarding state; if designated port is a port connected to point to point link, the device can handshake with the downstream device to give immediate response to enter forwarding state.

On [LACP / RSTP] page can observe the current port RSTP information on the switch, shown in figure 4-6.

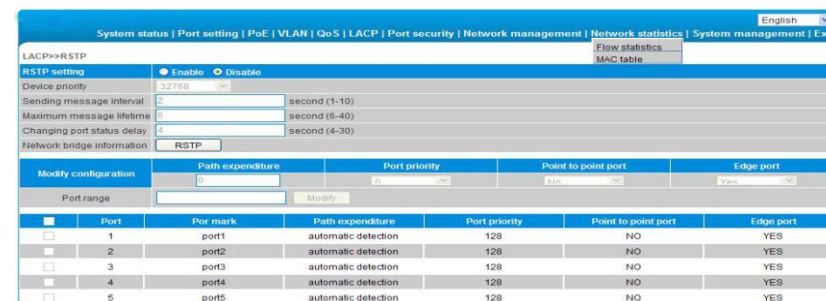

Figure 4-6 RSTP

The meaning of main parameters of the pages as below.

Table 4-8 Parameters description

Parameters	Description
Device priority	As the network bridge priority, network bridge and network bridge MAC address combined as bridge ID, of which minimum bridge ID will become the root network.
Sending message interval	The interval needed to sent a BPDU data packet.
Maximum message lifetime	Means the validity of a BPDU data package of a switch received from another switch.
Changing port status delay	The forward delay of a switch port status in transition status (listening and learning) .
Path expenditure	Setting port path cost, only setting when port default path cost on “off” status. Port link cost, with port priority and port ID form port ID to compare. Value range 1~200000000 “0”means automatic check.
Port priority	The priority of port in network bridge, with port priority and port ID form port ID to compare. Default port priority is 128.
Point to point port	Switch port and switch connected directly, then this port is P2P port, RSTP adopts negotiation mechanism for P2P port so as to achieve quick transformation of port status.
Edge port	The network edge switch generally connects with terminal equipments, such as PC, workstation. To configure these terminal ports to Edge ports can achieve status of transformation port without discarding Learning and forwarding transformation course.
RSTP information	Check RSTP information and port information

Configuration guide:

Enable RSTP function to avoid broadcast storm caused by looped network structure among switch A , switch B and switch C 1–10 port.

- Enable switch A, B, C RSTP function;
- Enter 1-10 within the Port range (or click box front of port) Equipment priority, cycle of sending message, maximum lifetime of information, default port status migration delay;
- Path cost, enter "0" is automatically detected;
- Port priority, choose "128";
- Point to point, choose "yes";
- Edge port, choose "No";
- Click save, operation finished.



Instruction

After setting RSTP, click "RSTP information" to check root bridge and port information. The port recover time is around 30s by default, click right key to refresh current status.

4.5 Port Security

4.5.1 Statics Address Latch

Statics MAC address is to limit computer operation, the computer with binding computer MAC and ports can not communicate with other ports, while other computer can do that.

On [Port security/Stastic address lock] page displays switch information of statics address latch, as shown in figure 4-7:



Figure 4-7 Port security

The meaning of main parameters of the pages as below. .

Table 4-9 Parameters

Parameters	Description
MAC Address	Static MAC address differs from the general dynamic MAC address. Once a static address is added, the address will remain in effect until be deleted and free the maximum aging time limited.
VLAN ID	Port-corresponding VLAN ID number
Port	Select a static MAC address to forward port, you can only specify one forwarding port.

Configuration Guidelines:

For example, when binding the port 10 of switch A with switch B, port 1 belongs to VLAN20.

- Enable static address latch function of switch B;
- Enter the MAC address of switch B;
- Enter VLAN ID with 20;
- Enter port with 20;
- Click Save;
- Operation finished.



Caution

This feature is a security mechanism which requires high attention to the settings:

Do not use a multicast address as a enter address;

Do not enter the reserved MAC address, such as local MAC address;

For port which has already been added to an aggregation group, it is not allowed to set binding function between port and MAC address.

4.5.2 802.1X certificates

IEEE 802.1X certification system adopted the "controllable port" and "uncontrolled ports" logic functions. It can realize the separation of business and certification. After passing certification, the business flow and the certification flow separation, it has no special requirement for the following subsequent packets. Business can be flexible, especially in develop broadband multicast business, it has a lot of advantages. All the business are not restricted by authentication.

802.1X Three Main Parts:

(1) Application supplicant : User and Client which want to get the certification;

(2) authentication server : A typical example for the RADIUS server;

(3) Certification System authenticator : Between the end devices, such as wireless access points, switches, etc We can play at the same time equipment system and authentication server two characters, you can also use the additional authentication server, at the same time support the billing system.

In [port security / 802.1X authentication] page, you can modify / 802.1X authentication function set, as shown in figure 4-8:

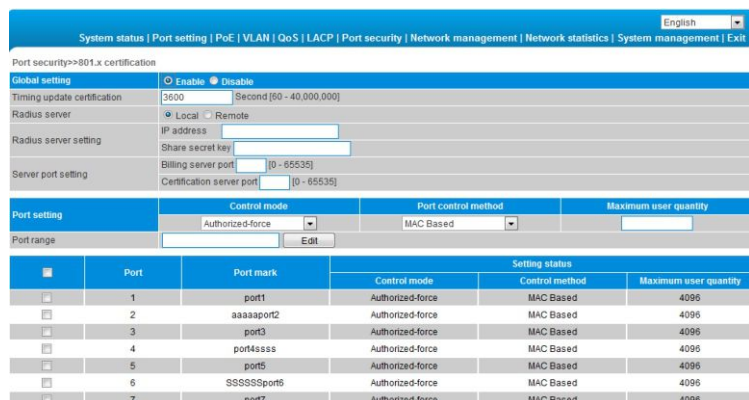

Figure 4-8 802.1X certificates

Table 4-10 Parameter Description

Specification	Description
802.1X config	On/Off 802.1X certificatin, default is off.
Regularly update the certificaion	802. 1X The certification cycle time, used to enhance the security of authentication.
Radius Server	Equipment built in the Radius server, if choose internal Radius of service. Applicants will only be used inside the Raduis database users and password. If the use of external Radius server need to fill in the authentication server IP address and Ports NO. If you need to use the AAA billing system, fill in server setting IP address and Ports No. Or Server setting IP address is Blank.
Authentication server IP address	Radius Remote access authentication server, namely certification authorization use,Set the IP address/domain is device can access to,The default port is 1812.
shared key	For device access authentication server Shared password string.
Service port Settings	Server implementation is the function of billing, set the IP address/domain is equipment can access. Default Ports is 1813.
control mode	Compulsory licensing model respectively, and the automatic mode, mandatory unauthorized mode.
Port Control mode	MAC Based.
Max ID list	Scope :1-4096.

Configuration Guide :

EX: Setting port 1-10 to compulsory licensing model, the maximum number of users to 10.

- Start using 802.1x Certification;
- Ports Scope choose 1-10, Control mode selection compulsory licensing, maximum number of users input 10;
- Click setting and save;
- Operation finished.

Instruction

- (1) Between the applicant and the authentication system using MD5 - inquiry, do not support others;
- (2) If the network connection properties without "authentication" option, please select "attachment" - > "management tools" - > "component services" - > "service", set "Wired AutoConfig" to "automatic";
- (3) Billing server setup error will also lead the applicant cannot be authenticated. No billing server does not need to set up
- (4) All uplink or downlink ports must be forced through the authentication, or prohibit the use of certification ", otherwise can't use the remote server, unless you use the internal authenticated server;
- (5) When using the remote server, the administrator can access the remote server, be sure to confirm equipment displaying "device address of the gateway set up correctly, if use the domain name the DNS must be set correctly.

4.6 Web Management

4.6.1 SNMP Setting

SNMP is used to ensure the management information transferred between any two points, so that network administrators can easily retrieve information on any node on the network to modify information, fault search, troubleshooting, capacity planning and report generation.

SNMP contains NMS and Agent, of which NMS is a workstation running the server-side program, while Agent is the client software running on net work device. NMS can send request message to Agent, after Agent receive request message from NMS, it starts to read or write and generate response packets and send the response packets back to the NMS.

On the [Network management / SNMP Settings] page, you can enable / disenable the SNMP service ad set the community name, etc as shown in figure 4-9.

Figure 4-9 SNMP Schematic configuration

The meaning of main parameters of the pages are as below.

Table 4-11 Parameter description

Parameters	Description
SNMP Gateway	Agent send the network IP address from receiver who send abnormal alert.
SNMP version	Only support V1/V2/V3 version.
Read-only community name	A SNMP community named after a string, the group only has permission to operate.
Read-write community name	A SNMP community named after a string, the group has permission to Get and Set operations.

Caution

Community name: used to define the relationship between the SNMP manager and an SNMP agent. If the community name SNMP packets have not been recognized by the device, the packet is discarded. You can use the standard community name (public or private) or a user-defined group name.

4.6.2 Email Alarm

The device if it is running an event supervision, the supervision sends an alert message to defined mail recipients when something wrong about defining time and some abnormal event occurs,. Supervision also periodically send all log messages to predefined recipients.

On the [Network management / Email alarm] page, you can turn on / off Email alarm service, shown in figure 4-10.

Figure 4-10 Email alarm

The meanings of main parameters of the pages are as below table.

Table 4-12 Parameters description

Parameters	Description
Mail Server	The host computer's IP address or the host computer that provide POP3 mail delivery service to our devices.
Email Accounts	The account name for logging in email server.
E-mail Password	The password to the account name for logging in email sever.
Recipient Address	The email address used to inform recipients of abnormal events.
Email Reply Address	The email address that can help solve abnormal events.
Mail interval	The interval time that regularly send log and weekly reports.

Configuration guidelines:

If a switch can not send message out, it should send alarm messages to the specified 163 mailbox.

- Enable Email alarm function;
- Enter your serve smtp. 163. com in the mail server;
- Enter the account ***@163.com in your email account to log in email server;
- Enter email password;
- Receipt email address should input email address of the email receiver ***@163.com;
- Enter recipient or webmaster email in email address, The address is ***@163.com;
- Mail intervals is 12 hours;
- Click Save to finish the procedure.

Caution

Some email service system requires that the "email reply address" should match the "email account"; when sending system test email, the password should be in plain text. The test mail can not be sent if the password is "*".

4.6.3 Port Mirror

Port mirroring refers to copying the monitor port data to a designated monitoring port ,For data analysis and monitoring , The Ethernet Switch support multiple mirroring to one mirroring, which Copy packets from multiple ports to a monitor port, User can also specify the direction of monitored packets, such as only monitor designated ports message. Equipment using port mirroring group way to configure port mirroring. Every port Mirror include monitoring port and be monitored port.

In[network management/ port Mirror] page, which could modify [port Mirror] function setting ,as the figure 4-11 show

Figure 4-11 Port Mirror

The page parameter as the sheet show:

Table 4-13 Main parameters Description

Parameter	Description
Port Mirror on/off	Turn on/off Port Mirror Function , Default is off
Monitor Port	Port for monitoring, the port display data is designated direction
Mirror Port	Be Monitored ports, these ports collect designated direction data from be monitored ports
Data Collection	Specifies the monitor port data direction was divided into "all data", "data import" and "export data" three options

Configuration Guidance :

Such as port 3 monitor port 2 Import data traffic

- Open Port Mirror;
- Input3 on monitor port, input 2 on mirror Port, Data collection selected from import data ;
- Press save after setting ;
- Finished.

Instruction

- (1)This feature must be turned off in normal use, otherwise, all based on advanced management capabilities port can use such as RSTP, IGMP SNOOP;
- (2)Mirroring only handles normal packet FCS, can not handle all kinds of erroneous data frame;
- (3)To replace the mirror port or monitor port, directly input monitoring port number or Mirror port number, and then click Setting.

4.6.4 IGMP Snooping

Switch IGMP membership report message to the router IGMP membership through intercepting mainframe. Form Corresponding relationship between group members and switch interfaces ; Switch transfer multicast packets be received to member group ports according to Correspondence.

[Network Management/ IGMP Snooping] Page, Modify and setting [IGMP Snooping] function as the figure 4-12 show .

Figure 4-12 IGMP Snooping

Multicast Snooping Parameter meaning as shown in the Table:

Table 4-14 Major Parameter Description

Parameter	Description
IGMP Snooping On/Off	Opening and Closing Multicast Snooping function ,Default is Close.
IGMP Inquiry	Open IGMP Multicast Inquiry function
IGMP Query interval	Open IGMP Qurey Function, Check Existing Multicast Members for one time
Member Existing Time	The longest time of equipment Existing multicast Member survival time
Unknown multicast group forwarding table	How to transfer those ports When the received multicast address does not exist in the address table



Instruction

- (1)PC's Ethernet port should be allocated only one IP address is recommended;
- (2)Network is best not to have multiple IGMP inquirer;
- (3)Please choose all the port If you are unsure forwarding relationship to unknown multicast group

4.7 Network Statistics

4.7.1 Network Statistics

On the [Network statistics / Flow statistics] page, you can view the number of data packets and bytes transferred for each port, shown in figure 4-13.

Port	Singlecast package	Multicast package	Broadcast package	Error package	Singlecast package	Multicast package	Broadcast package	Error package
1	0	0	0	0	0	0	0	0
2	0	0	0	0	0	0	0	0
3	0	0	0	0	0	0	0	0
4	0	0	0	0	0	0	0	0
5	0	0	0	0	0	0	0	0
6	0	0	0	0	0	0	0	0
7	0	0	0	0	0	0	0	0
8	0	0	0	0	0	0	0	0
9	0	0	0	0	0	0	0	0
10	0	0	0	0	0	0	0	0

Figure 4-13 Traffic statistics

The main parameters of the above illustration are described in the table below.

Table 4-15 The description of the main parameters

Parameters	Description
Receive Frame singlecast Package	The received address is the number of packets in the unicast address.
Receive Frame multicast Package	The received address is the number of packets in the multicast address.
Receive Frame Broadcast Package	The sent received address is the number of packets in the broadcast address.
Receive Frame Error Package	Error package numbers due to various wrong reasons sent and received by ports.
Send Frame Singlecast package	The sent address is the number of packets in the unicast address.
Send Frame Multicast Package	The sent address is the number of packets in the multicast address.
Send Frame Broadcast Package	The sent address is the number of packets in the broadcast address.
Send Frame Error Package	Error package numbers due to various wrong reasons sent and received by ports.

4.7.2 MAC Address

MAC (Media Access Control) address is the hardware identification of network equipment. Switches could transfer message according to MAC address. MAC address is unique, which ensures the correct message. Every switch maintains a MAC address table, in which, the MAC address corresponds to switch ports. The switch could decide to filter this data frame or transfer data frame to corresponding port according to MAC address table when the switch receives data frame. MAC address is the basic and premise for data frame fast forwarding.

On [Network statistics /MAC table] page, you could check MAC address of each port, as the figure 4-14 shows:

No.	Source address	VLAN ID	Type	Port	Process mode
1	20:4E:7F:89:D8:97	1	Dynamic	28	forward
2	00:24:8C:95:AD:4C	1	Dynamic	28	forward
3	50:E5:49:AF:46:97	1	Dynamic	28	forward
4	54:04:A6:D5:88:5F	1	Dynamic	28	forward
5	14:DA:E9:93:02:64	1	Dynamic	28	forward
6	00:0C:29:29:D2:60	1	Dynamic	28	forward
7	00:1F:29:9A:88:E6	1	Dynamic	28	forward

Figure 4-14 MAC address table

The main parameter description are shown as the table.

Table 4-16 Main parameter

Parameter	Description
Inquiry by physical port	Enter detailed physical MAC address to check.
Inquiry by MAC address type	MAC address type consists of static MAC address and dynamic MAC address.

Caution

Multicast MAC address table is displayed in IGMP snooping table, all these address tables are unicast addresses, The permanent static address is configured in static MAC address port table. You need to modify corresponding entries when the port changes. The aging time of MAC address is 300s, after port disconnected, the upper port operation procedures clear all correspond port entries.

4.8 System Management

4.8.1 IP Address

IP address is a 32 bit length address connected on Internet equipment. IP address consist of two parts: Network-Id and Host-Id.

On this page, you can check the IP address and etc for this device, just shown in figure 4-15.

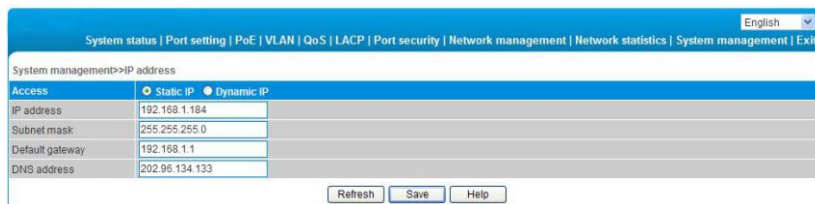

Figure 4-15 IP address

Caution

- (1) We could set IP address range as 192.168.x.x,172.[16-31].x.x or 10.x.x.x ;
- (2) Please fill in correct DNS address when using it for NTP and EMAIL.

4.8.2 User Management

On this page, you could modify or add one user with password . as figure 4-16.

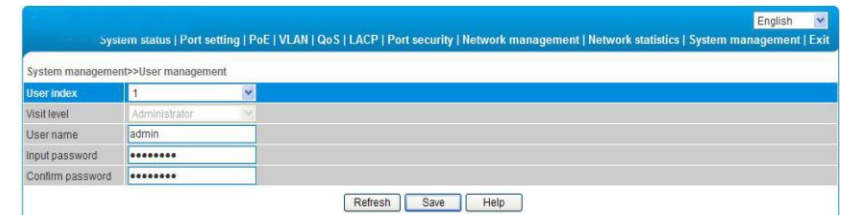

Figure 4-16 User management

The description of main parameter as the table shown.

Table 4-17 Main parameter

Parameter	Description
User Index	User index indicates the group of users, There are three user indexes in drop down table.
Visit Level	Administrator: view and set all configuration. User: some functions.
User Name	The identification of visitors. The combination of alphabet and Chinese character.
Input Password	Visitor password, the combination of alphabet and Chinese character.
Confirm Password	Password confirmed.

Instruction

Users enjoy the permission rights of all functions except for “power configuration”, delete all logs”, “update software” and “restore factory setting”.

Caution

- (1) If you forget your user name and password, please contact technical support in order to get help.
- (2) Set the same user name, only the top user / password could work.
- (3) Web supports up to one administrator and two ordinary users, administrators can not be deleted.

4.8.3 Log Information

The log function allows users to access system operation, When this function is enabled, corresponding events are recorded to the log:

- (1) System restart;
- (2) Port Link Down/UP;
- (3) Power supply status;
- (4) login information;
- (5) Broadcast storm;
- (6) System action and operation record;
- (7) NTP time synchronization information;
- (8) Other system information.

On [System management/ Log information] page, you could check the time and type of event, as shown in the figure 4-17.

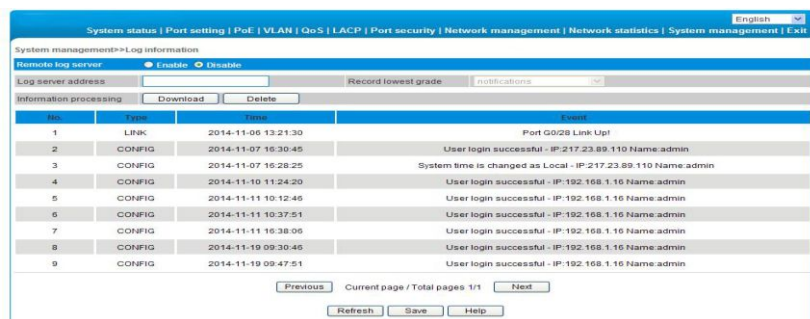

Figure 4-17 Log information

The received frame statistics and transmit frame statistics are shown as the table.

Table 4-18 Part of error package description

Parameter	Description
Log Sever Address	The server address receiving log information.
Record lowest grade	There are eight optional levels: error information, notification information to be logged, information in need of quick reaction, serious information, information that can not be used in system, normal but important information, information in debug, warning information.
Download All Information	Download all information (Format. cfg).
Delete All Information	Deleted all information.

4.8.4 File Management

On [System management/ File management] page, You could check configure document, software upgrade, restore factory setting and reboot system as shown in the figure 4-18.

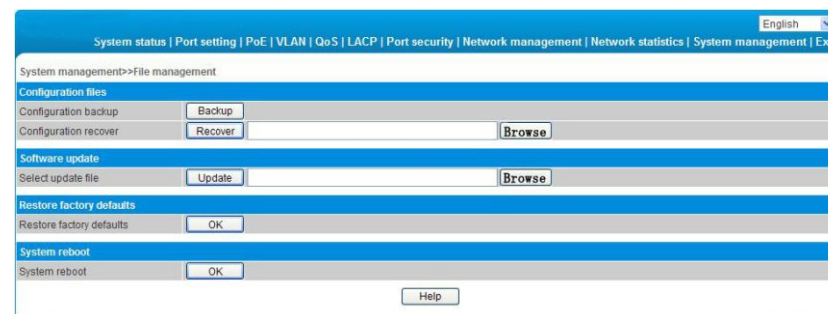

Figure 4-18 Document management

The main parameter descriptions are shown as the following table.

Table 4-19 Main parameter description

Parameter	Description
Configuration File	Backup switch configuration (File format . cfg) ; Select configuration file you want to restore and restore all configuration of switch (File format . cfg).
Software Update	Select the software you want to upgrade.
Restore Factory Defaults	Recover all configuration except for IP address, user name and password.
System Reboot	Restart system and return to system status page.

Caution

- (1) Please keep the switch energized during the upgrade process and do not off the power.
- (2) Please save configuration before rebooting, otherwise the unsaved configuration information will lose.

4.9 PoE Management

On PoE management page, you could turn on/off PoE function, set input power, maximum overload, reservation power etc, as shown in figure 4-19.

The screenshot shows a web-based configuration page for PoE management. It includes sections for 'Power setting', 'Power status', and 'Port status and control'. The 'Power setting' section shows 'Power provided' as 360 W, 'Overload limit' as 5%, and 'Reserved rate' as 15%. The 'Power status' section shows 'Consumed' as 0 W, 'Remaining' as NaN W, 'Reserved' as 54 W, and 'Provided' as 360 W. The 'Port status and control' section shows a table of ports with columns for Port, Port mark, Consumed (W), Power limit (W), Priority, and Port status.

Port	Port mark	Consumed (W)	Power limit (W)	Priority	Port status
1	port1		25	Low	open
2	port2		30	Low	open
3	port3		30	Low	open
4	port4		30	Low	open
5	port5		30	Low	open

Figure 4-19 PoE management



Caution

- (1) Please do not modify the input power, if the setting value is more than the actual power of the built-in power, there will be a risk of overload burning. If the setting value is less than the actual power for the built-in power supply, it can not be fully allocated out.
- (2) Each port of the product is to provide maximum output power of 30W, if user setting exceeds 30W, 30W is still the maximum power output only.

The information of main parameter description as the table shown.
Table 4-20 Main parameter description

Parameter	Description
Power provided	Determined by built-in power supply module and can not exceed maximum power supply.
Overload limit	Built-in power supply allows overload rate. Setting range 0%~10%, default 5%, if actual output power is overlarge, it will cause built-in power supply exceeds the set value, the system will power off ports with lower priority.
Reserved rate	Reservation power can not be used for distribution, but can be used for PD consumption caused by overload change, The default is 15% of the total power. The larger this number, the smaller the risk of system overload, So the usable power for distribution and PD quantity become less; on the contrary, the more the number of PD access, the greater risk of system overload.
Consumed	Actual output total power.
Remaining	Means power that could be used for redistribution. surplus= input - actual output - reservation. Please note that when insert a new PD equipment, the power will be distributed based on the detected PD power level instead of the actual power of inserted PD, for example: when surplus power is 20W, the system still can not distribute power nor supply power if insert power level of PD is 25.5W and the actual power only requires 10W.
Reserved	Used for PD consumption with overload changes, It stems from the set menu "input power rate * reserve power".
Provided	Total power for system setting, It stems from the set menu "input power".
Priority	There have three level of "low", "middle", "high" for port power supply priority. when the system is overloaded, the power supply of the port with low priority will be turned off firstly.
Power limit	Set the output power limit for single port., the port will power off when actual output power exceeds limit.
On/Off	Power on the port POE function /power off the port POE
Setting	Sett port priority, maximum power consumption.

4.10 QoS Management

4.10.1 QoS setting

On the QoS management/QoS Settings page, you can modify / 802.1 P QoS function setting, as shown in figure 4-20.

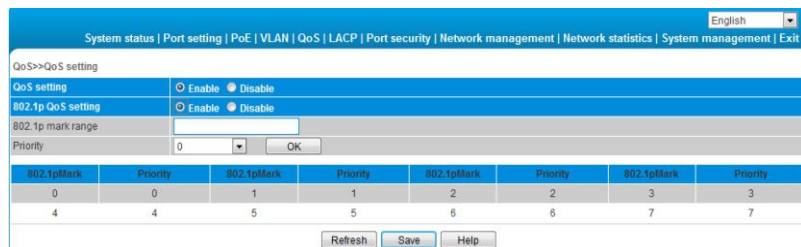

Figure 4-20 802.1P QoS

The meaning of parameters in the page is shown in the following table.

Table 4-21 Main Parameter

Parameter	Description
QoS Setting on/Off	On/Off QoS function, Default is Off
802. 1P QoS config	Traffic priority, 802. 1P define in 8 Priority, the highest priority is 7, then to 6、5、4、3、2、1、0
802. 1P Scope	Identify scopes is 0、1、2、3、4、5、6、7, Total 8 ID, 0 As the default value, The absence of other priority value set automatically enabled
Priority	Priority for 0 queue to queue, 7, 7 queue as the highest priority queue

Configuration guide:

Example: Setting ID 6、7 to Lowest queue.

- Turn on QoS setting & 802.1P QoS Setting;
- 802.1P ID scope Input 6-7, Priority set line 0;
- Click Settings, then save;
- End of operation.



Instruction

The arrangement of equipment use for the WRR queue scheduling, priority mode for the relative priority. Equipment in the default setting priority 0 and 1 is mapped to the first priority queue. Namely the lowest priority queue. Priority 2 and 3 mapped to the second priority queue. 4 and 5 priority priority mapping to the third queue. 6 and 7 mapped to the highest priority priority queue is the highest priority queue.

4.10.2 DSCP/TOS QoS

[QoS Setting/ DSCP/TOS QoS] Interface, can modify the setting [DSCP/TOS QoS], figure 4-21

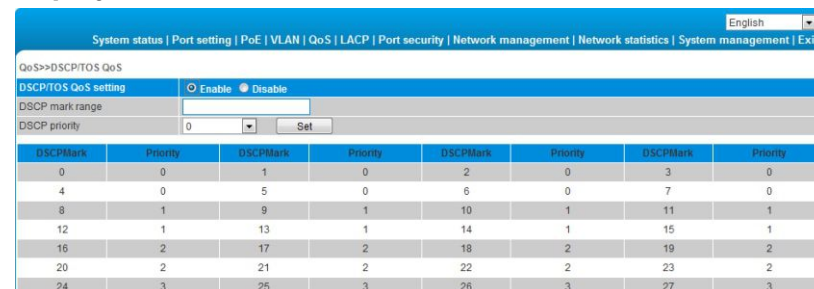

Figure 4-21 DSCP/TOS QoS

The meaning of parameters in the page is shown in the following table

Table 4-22 Main Parameter Description

Parameter	Description
DSCP/TOS QoS	ON/OFF DSCP/TOS QoS, Default is Off
DSCP Scope	TOS Identifies scope, Scope is 0-63
DSCP Priority	TOS Priority, priority for zero queue to queue, 7 7 queue for priority

Configuration guide:

For example the id 0-16 is set to the highest queue.

- Start using DSCP/TOS QoS configuration;
- In DSCP ID scope Input 1-10, DSCP Priority Choose the seventh queue priority;
- Click Setting and save
- End of operation.



Instruction

When start using 802.1P & DSCP/TOS QoS at the same time, DSCP/TOS QoS Priority First.

Environment protection

This product design is environmental friendly and the product should be stored, used and discarded in accordance with relevant national legal / regulatory requirements.